

Brighton 4-Panel Swing Door Installation Guide

Brighton 4-Panel Swing Door REV. 08/2019

Not Available for Luxury



Brighton 4-Panel Swing Door

Scan Here for a Digital Version of the
Installation Guides in English.

Quartz Residential Windows & Doors:
www.quakerresidentialwindows.com

Not Available for Commercial



Para ver las instrucciones en Espanol, escanea aqui.

If this set of instructions does not match your installation method or the wall conditions of the job site, please check our website listed below for other options, or call Quaker Customer Service for additional information.



Quaker Window Products
504 U.S. Hwy 63 South
Freeburg, MO 65035
(800) 347-0438
www.quakerwindows.com





Quad Door Panel Astragal Installation Instructions





Equipment Needed

- Hammer
- Measuring Tape
- Block of Wood
- Screw Driver

Parts List

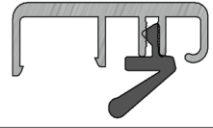
- Interior Astragal (1) : Wood 
- Exterior Astragal (1) : Clad – Aluminum 
Prime – Wood 
- #8 x 1 1/2" Flat Head Screws (12) 

PROFILE	FINISH	CALL OUT	PART #
	PINE	6-10	220168
	PINE	8-0	220169
	ALDER	8-0-A	220169-A
	FIR	8-0-F	220169-F
	INTERIOR ASTRAGAL WEATHERSTRIP		8046-1
	MILL	8'4"	8249-1
	EXTERIOR ASTRAGAL WEATHERSTRIP		2384100
	INTERIOR ASTRAGAL SCREWS	#8 x 1 1/2" FLAT HEAD	8091

Note: Astragal instructions should occur after adjusting rollers on door panels

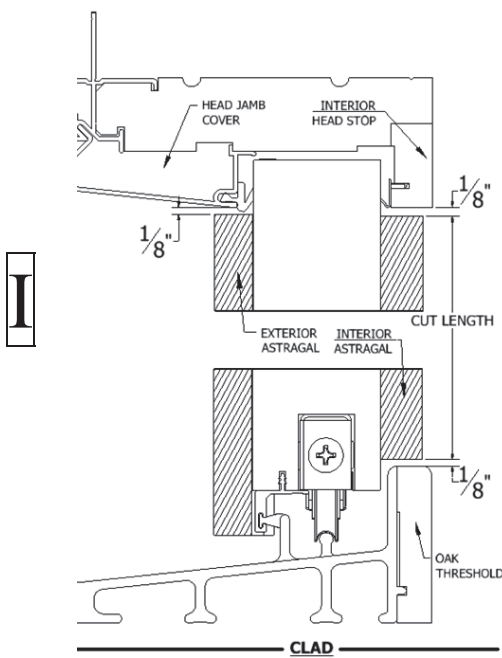

INTERIOR ASTRAGAL

1. Interior Astragal is Pre-Cut to length

EXTERIOR ASTRAGAL

1. Exterior Astragal is Pre-Cut to length

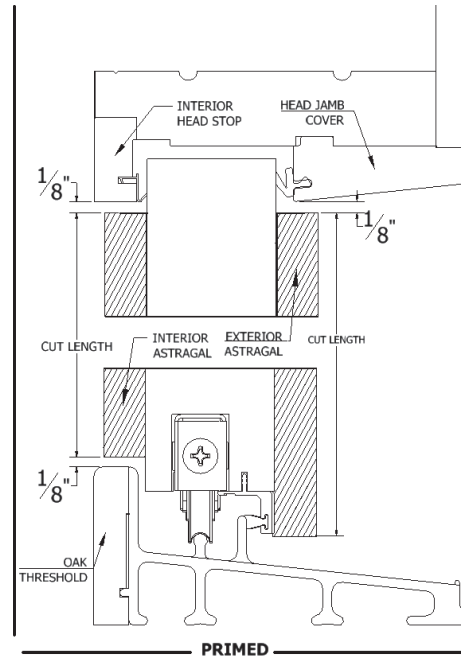

CLAD (EXTERIOR)

1. Place the Exterior Astragal over the Astragal Bracket in the location shown in Section I.
2. Starting from the bottom, working your way to the top, place a block of wood on the face of the Exterior Astragal and tap with a hammer until it snaps in place.

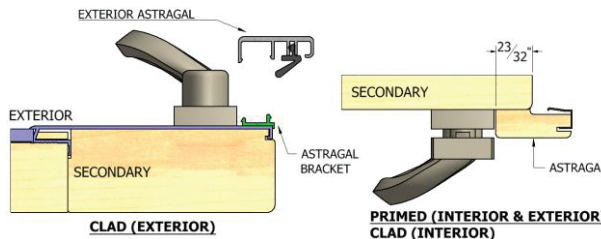

PRIMED / CLAD (INTERIOR)

1. Place the wooden astragal in vertical location shown in Section I.
2. Align the astragal 3/4" from the edge of the stile (Shown on left).
3. Secure astragal by following Section 3, shown below.



SECURING ASTRAGAL

1. Position the astragal as stated in Sections I and II.
2. Using #8 x 1 1/2" flat head screws found in the hardware bag, install screws 10" apart along the length of the astragal 3/8" from the edge of the astragal (Shown on right).

